

PRESTO®

CoolDaddy® cool-touch deep fryer

- Delicious deep fried foods, fast and easy.
- Exterior handle lowers food into the oil with the cover closed to prevent spattering.
- Extra large viewing window lets you supervise frying without opening the cover.
- Removable pot for quick and easy cleaning.



Estas instrucciones también están disponibles en español.

Para obtener una copia impresa:

- Descargue en formato PDF en www.GoPresto.com/espanol.
- Envíe un mensaje de correo electrónico a contact@GoPresto.com.
- Llame al 1-800-877-0441, oprima 2, y deje un mensaje.

©2011 National Presto Industries, Inc.

INSTRUCTIONS/RECIPES

Visit us on the web at
www.GoPresto.com

This is a  Listed appliance. The following important safeguards are recommended by most portable appliance manufacturers.

IMPORTANT SAFEGUARDS

To reduce the risk of personal injury or property damage, when using electrical appliances, basic safety precautions should always be followed, including the following:

1. Read all instructions.
2. Do not touch hot surfaces. Use handles.
3. Be sure handle is properly assembled to basket and locked in place. See detailed assembly instructions on page 4.
4. To protect against electrical shock or burns, do not immerse unit, cord, or plug in water or other liquid.
5. Close supervision is necessary when any appliance is used by or near children.
6. Do not let children handle or put electrical cords or plugs in their mouths.
7. Always attach magnetic plug end to appliance first, then plug cord into the wall outlet. To disconnect, remove plug from wall outlet, then from appliance.
8. Unplug from wall outlet when unit is not in use and before cleaning. Allow to cool before putting on or taking off parts, and before cleaning the appliance.
9. Do not operate any appliance with a damaged cord or plug or in the event the appliance malfunctions or has been damaged in any manner. Return the appliance to the Presto Factory Service Department for examination, repair, or electrical or mechanical adjustment.
10. The use of accessory attachments not recommended by the appliance manufacturer may cause injuries.
11. Do not use outdoors.
12. Do not let cord hang over edge of table or counter or touch hot surfaces.

13. Do not place on or near a hot gas or electric burner or in a heated oven.
14. It is recommended that this fryer not be moved when it contains hot oil or other hot liquid. If it must be moved when it contains hot oil or other hot liquid, use extreme caution.
15. Do not use appliance for other than intended use.

SAVE THESE INSTRUCTIONS

THIS PRODUCT IS FOR HOUSEHOLD USE ONLY.

IMPORTANT CORD AND PLUG INFORMATION

A short power supply cord is provided to reduce the risk resulting from becoming entangled in or tripping over a longer cord. **DO NOT USE WITH AN EXTENSION CORD.**

Do not allow the cord to run underneath or around the unit. The magnetic cord may not detach easily if the cord is positioned in this fashion.

Connect the power supply cord to a 120v AC electrical outlet only.

Important Fryer Guidelines

- ◆ **Use deep fryer only on a clean, dry, level, stable, and heat-resistant surface, away from countertop edge.**
- ◆ Hot oil can cause serious and painful burns. Close supervision is necessary when any appliance is used by or near children.
- ◆ To avoid the risk of electrocution or severe disfiguring electrical burns, do not let children handle or put electrical cords or plugs in their mouths.
- ◆ To avoid the risk of electrocution or electrical burns, do not let the cord or plug come in contact with water or other liquid.
- ◆ Never use the deep fryer without the removable pot.
- ◆ Never use the deep fryer without oil or with insufficient oil. Failure to fill fryer with oil to the minimum (MIN) fill level will cause overheating and damage to the product. Also never exceed the maximum (MAX) fill level. Using more than the maximum amount may cause the oil to boil over the top of the fryer. The MIN and MAX fill levels are embossed inside the removable pot (Fig. H, page 4).
- ◆ Use vegetable oil, such as corn, sunflower, peanut, or soybean, for deep frying. Deep frying foods in butter, margarine, olive oil, or animal fat is not recommended because of lower smoking temperatures.
- ◆ **CAUTION: OIL AND WATER DO NOT MIX.** The combination can be dangerous. When the oil is heated, any water droplets in the oil super-heat, becoming a volatile steam that can cause hot oil to spatter, boil over, or even erupt out of the deep fryer. **Hot oil can cause severe burns!**

Accordingly, before pouring oil into the removable pot be sure that the pot and all parts are COMPLETELY dry. Before placing food in deep fryer, always remove ice crystals and excess moisture from food by patting dry with toweling.

- ◆ Use caution when deep frying doughs, such as beignets, donuts, dumplings, hushpuppies, and fritters. These foods may develop air bubbles during heating, which may burst and cause burns. Use a slotted spoon or tongs, rather than a fork, when turning food during frying and also when removing food from oil.
- ◆ Use caution when deep frying flour tortillas. Flour tortillas contain air bubbles. During deep frying, oil can become trapped within these bubbles. If not properly drained, the bubbles can burst and cause burns. Therefore, after deep frying tortillas, carefully raise them out of the cooking oil and allow oil to drain from the tortillas for approximately 30 seconds.
- ◆ Use caution when deep frying raw fries. See special notes on page 5, the Frying Timetable on page 7, and Raw French Fries recipe on page 8.
- ◆ Always remove plug from wall outlet and then from deep fryer when unit is not in use.
- ◆ Always allow fryer to cool completely with cover closed before removing oil and cleaning.

Before First Use

Become familiar with the various parts of the deep fryer (Fig. A) and read the instructions carefully.

Cleaning before first use...

Wipe the fryer cover and cool-touch fryer base with a damp cloth. **Never immerse the fryer base in water or other liquid. Never wash the cover parts or fryer base in a dishwasher.**

Open the deep fryer cover by pushing the cover release button on the front of the fryer. Remove the frying basket, basket handle, charcoal air filter, and any packaging material from the deep fryer. Then lift the removable pot out of the fryer base. Wash both the basket and removable pot in hot, soapy water; rinse and dry thoroughly. Washing the removable pot in a dishwasher is not recommended. If you choose to wash the removable pot in a dishwasher, the exterior of the removable pot will likely discolor due to the caustic nature of the dishwasher detergent.

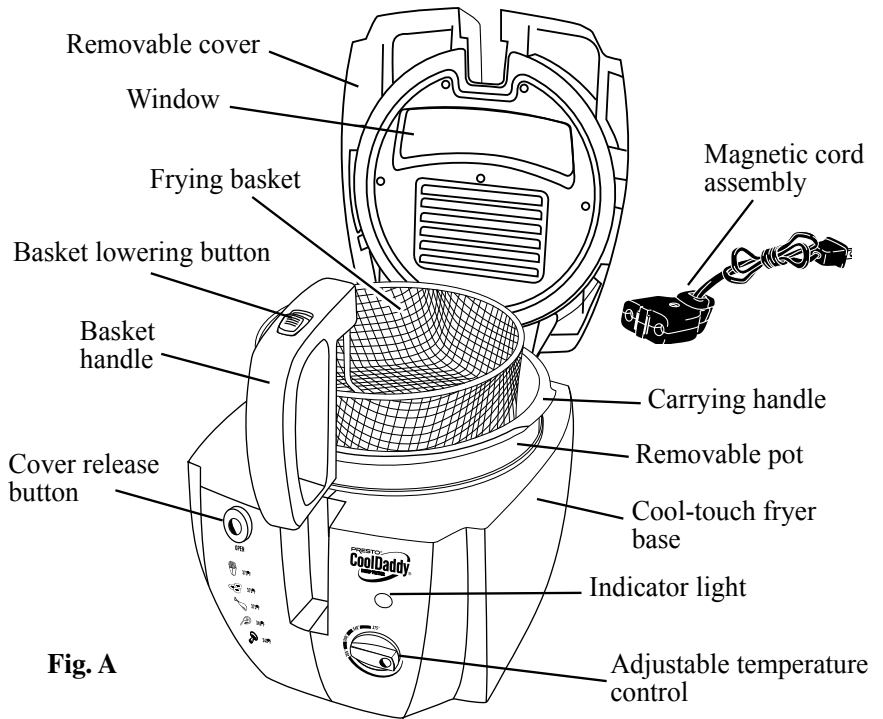

Positioning removable pot in fryer base...

After cleaning, place the removable pot back in the fryer base. The terminal pins on the bottom of the removable pot fit in the receptacle inside the fryer base (Fig. B). For easiest alignment, position the pot in the base so the ▼ on the front of the pot aligns with the front seam of the unit (Fig. C). Then tilt the pot forward slightly and push pot down into fryer base. If the fryer cover closes, you will know the removable pot is positioned correctly.

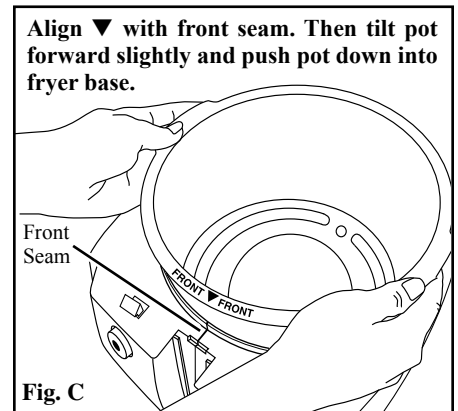
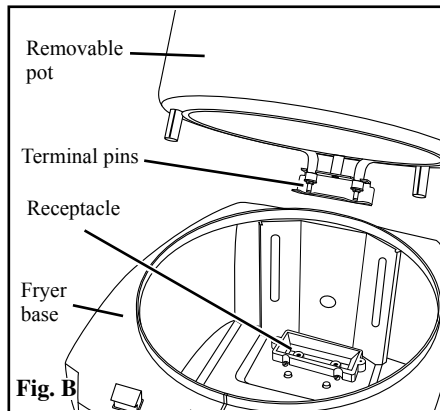

Installing/replacing removable filter...

The mesh charcoal filter, which is located in the cover of the deep fryer, will help absorb unpleasant odors. For the deep fryer to effectively absorb these odors, always use the fryer with the filter in the cover.

To install or replace the filter, first close the fryer cover. Then, remove the filter cover (Fig. D) by pushing the release latch towards the window and lift up on the back of the filter cover. If replacing an old filter, remove old filter and discard. Unwrap new charcoal filter and insert it in the filter compartment. Replace the filter cover and snap into place by pushing down.

Replacement filters may be purchased through the Presto Consumer Service Department. Call 1-800-877-0441 (see page 10) or order on the web at www.GoPresto.com.

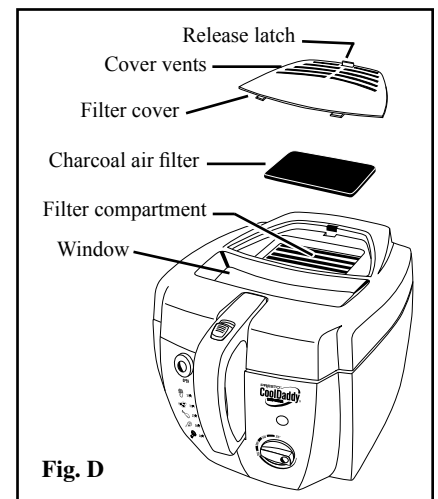

Attaching basket handle to basket...

Before using the deep fryer, you will need to attach the basket handle to the basket. Follow these steps:

1. Hold the basket in one hand and the basket handle in your other hand. You will be placing the pegs, which are at the ends of the two basket handle bars, into the two holes in the basket bracket (Fig. E).
2. While holding the pegs near the peg holes, tilt the handle inward before attempting to place the pegs in their holes. (You will not be able to fit the second peg into its hole if the handle bars are positioned too close to the bracket.)
3. Next, place one of the pegs in one of the peg holes. Then squeeze the handle bars together and fit the opposite peg in the other peg hole (Fig. F).
4. While continuing to squeeze the handle bars together and keeping the pegs in the holes, rotate the handle towards the basket rim, allowing the handle bars to snap into the tabs on the basket bracket (Fig. G). The handle is now in the locked position.

For instructions on how to insert and position basket in fryer, see step 3, page 5.

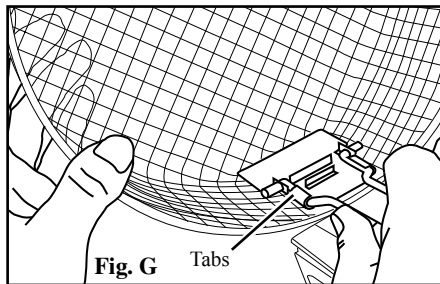
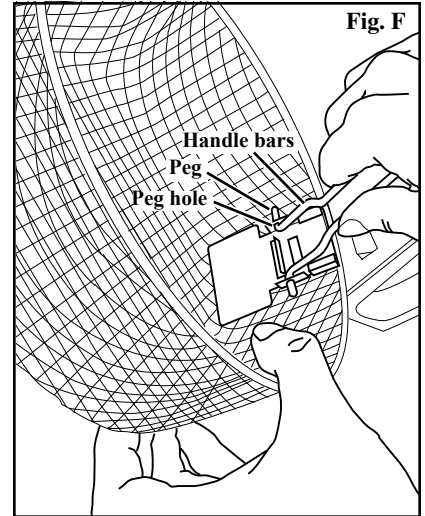
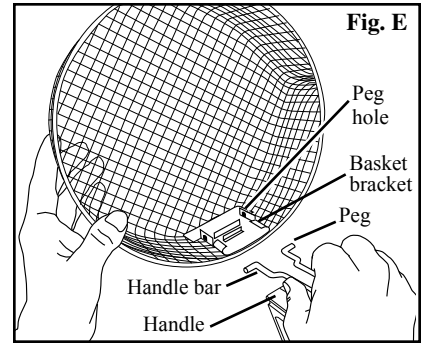

How To Use

To fill with oil...

1. Open the deep fryer cover.
2. If the frying basket is in the fryer, remove it and set it aside.
3. Fill the removable pot with cooking oil or shortening up to the maximum oil level line (MAX) which is located on the inside of the removable pot (Fig. H). Use eight, 8-ounce cups of cooking oil or four pounds of shortening. The amount of oil in the removable pot must always be between the MIN and MAX level markings inside the removable pot. Never exceed the MAX level mark.

To preheat...

1. Close the fryer cover.
2. Attach the cord to the unit by aligning the magnetic plug end of the cord assembly with the two electrical pins located in the recessed area of the fryer base (Fig. I). When properly aligned, the plug will magnetically attach itself to the appliance. **For proper connection, the magnetic plug end must be parallel with the countertop** (Fig. J).

Important: The magnetic cord was designed to detach easily from the fryer. As a result, if it is bumped or touched during use, it could possibly detach causing the unit to stop heating. Avoid contact with cord during operation. If contact occurs, verify that the cord is still properly connected.

3. Plug cord into a 120v AC electrical wall outlet only. Turn the adjustable temperature control (Fig. A, Page 3) to the desired temperature (see page 7 for proper cooking temperatures). The recommended setting for most frying is 375°.

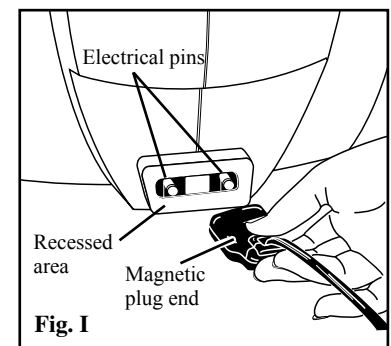
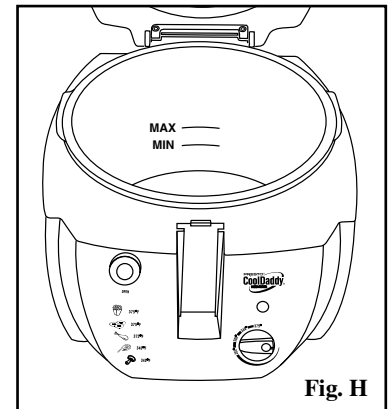

Note: When using the fryer for the first time, a slight odor or light smoking may occur as manufacturing residue evaporates. This is normal during initial use.

4. The fryer requires a 12 minute preheat time to allow oil to reach the proper cooking temperature.
5. While oil is preheating, prepare food for cooking.

WARNING: To prevent risk of severe personal injury or property damage, use caution when cooking with hot oil.

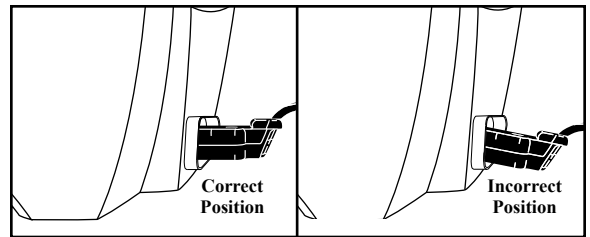

Fig. J For proper connection, the magnetic plug end must be parallel with the countertop.

To fry...

1. While frying basket is sitting on countertop, fill basket up to $\frac{2}{3}$ full with food.
NOTE: For raw fries, only fill basket $\frac{1}{2}$ full.
2. Push the cover release button to open the cover. **CAUTION: The unit has a special cool-touch exterior; however, the interior of the fryer is extremely hot and should not be touched.** If the cover does not open completely, slowly tilt the cover back to an upright position being careful not to touch hot surfaces.

3. Place the filled frying basket in the removable pot, aligning the grooves on the sides of the basket handle with the slot guides on the front of the base (Fig. K and Fig. L), and lower the basket until it stops. This is the drain/load position.

4. With your hand on the top of the cool-touch cover, pull it down to the closed position, then press down until it locks in place.

NOTE: When frying raw fries, leave cover in open position until basket has been lowered into oil.

5. Slide the basket lowering button forward to lower the basket into the oil.
6. Begin timing. Refer to page 7 for recommended times. During the first few minutes it is normal for steam to appear on the viewing window. This will slowly disappear during cooking if the window is kept clean between uses.

CAUTION: It is normal for steam to escape from the cover vents during frying. To prevent steam burns, keep hands and face away from the vents.

Note: High moisture foods, such as french fries, produce more steam than other foods. The fryer is designed to ensure that excessive moisture does not remain in the fryer. Thus when frying moist foods, you may see beads of condensation on the exterior of the fryer. This is normal.

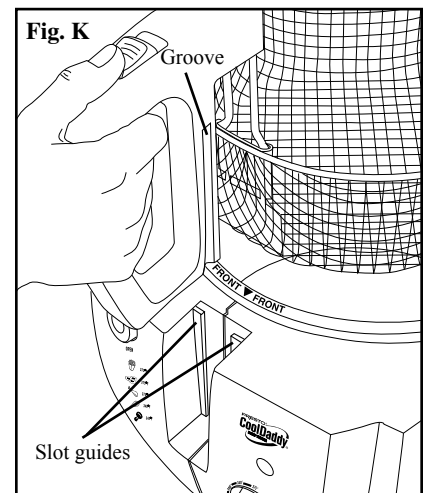

7. When frying time has elapsed, lift up on the basket handle to raise the basket to the drain position.

8. Push the cover release button to open the cover. Allow the steam to vent and then slowly tilt the cover back to an upright position being careful not to touch hot surfaces. Check that the food is golden brown. If more cooking time is needed, close the cover and slide the basket lowering button forward to lower the basket back into the oil.

9. Once the food is done, carefully lift the basket out of the fryer. Then empty the food on absorbent paper. Season to taste.

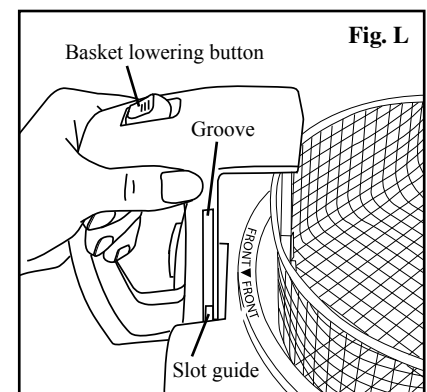

10. If frying additional food, close fryer cover and wait for indicator light to go out. Then repeat steps 1 through 9.

Care and Cleaning

1. Remove plug from wall outlet and then from deep fryer and allow oil and fryer to cool completely with the cover closed.
2. After unit has cooled completely, open cover. Lift the removable pot out of the deep fryer using the two carrying handles.
3. If you plan to reuse the cooking oil, it is recommended that you strain the oil to remove any food particles. Store oil in a tightly sealed container and keep where it will not be exposed to heat or direct light.
4. Detach the basket handle from the basket and wipe handle with a damp cloth to clean. To detach the basket handle for cleaning, squeeze the handle bars together and tilt the handle towards the interior of the basket. While continuing to squeeze the handle bars, remove the pegs from the peg holes.
5. Wash the frying basket, with the handle removed, and the removable pot with warm water and a mild detergent. Rinse and dry thoroughly. Do not use steel wool scouring pads on the removable pot or the cool-touch base. If necessary, clean oil residue with a heavy-duty nylon abrasive scouring pad and a chlorine cleanser. The frying basket, with the handle removed, may be washed in the dishwasher, if desired. Washing the removable pot in a dishwasher is not recommended. If you choose to wash the removable pot in a dishwasher, the exterior of the removable pot will likely discolor due to the caustic nature of the dishwasher detergent.
6. Never immerse the cool-touch base in water or other liquid, or wash in a dishwasher. Wipe with a damp cloth to clean.
7. After each use, wipe the inside of the fryer cover with a damp cloth. For a more thorough cleaning, remove the cover from the fryer base by opening the cover and then lifting it straight up.

Press the release latch on the filter cover (Fig. D, page 3) and remove the filter. The filter should not be washed. Wash the cover in hot, soapy water; rinse and dry. **Do not wash the cover parts in the dishwasher.** Dry the cover in a vertical position to allow water to drain out. Once the cover is thoroughly dry, reattach it to the fryer base.

Always remove the filter before immersing the cover in water.

8. On the back side of the deep fryer is a slide-out drip cup (Fig. M). This cup collects condensation from the fryer cover when the cover is opened after frying. Empty the drip cup after each use and replace in fryer with the rib side out.
9. Store the cord in a clean, dry location away from metal objects. Always check the magnetic plug before use to assure metal items have not become attached.

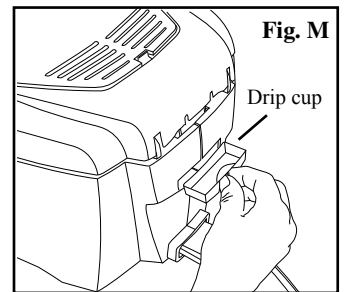

Questions and Answers

How do I know the removable pot is installed correctly?

If you are able to close the fryer cover tightly, the removable pot is installed correctly. If the cover does not close, reposition the pot following the instructions on page 3.

The basket lowering button moves, but nothing happens. Why?

The basket is probably not positioned correctly in the fryer base. If you look at the basket handle, you will notice a long groove on each side of the handle. These grooves need to be lined up with the slot guides on the fryer base (see Fig. K and Fig. L on page 5). Doing this enables the basket to be lowered partially into the fryer. The basket lowering button is then used to lower the basket the rest of the way into the hot oil. If the handle is not positioned correctly in the slot, the basket lowering button will not function.

Whenever I make battered foods, they stick to the basket. What can I do?

Battered foods work best when fried without the basket. When using the fryer without the basket, a heat-resistant scoop may be used to add or remove foods. These heat-resistant scoops may be purchased on the web at www.GoPresto.com.

Sometimes my fryer won't heat up or it stops working while I'm frying. Why?

If your fryer fails to preheat or if the cooking process stops while you are frying, check cord assembly to assure plug is properly attached to the appliance (see Fig. J, page 5).

My food doesn't get as crisp as I'd like and sometimes is unevenly cooked. What am I doing wrong?

You may have overfilled the fryer. If too much food is fried at the same time, the food will not get crisp. Do not fill the basket more than $\frac{2}{3}$ full.

If your food is unevenly cooked, you may be frying foods that are not uniform in thickness or size. Try frying foods of equal size and thickness as they will fry more evenly and at the same speed.

Helpful Hints

- ❖ Before deep frying, always remove excess moisture or ice crystals from food by patting dry with toweling. Even small amounts of moisture may cause the oil to spatter, pop, boil over, or erupt.
- ❖ When breading foods, use commercial breading, finely ground bread or cracker crumbs, corn meal, a mixture of corn meal and flour, pancake mix, or prepared bread mixes.
- ❖ Use only heat-resistant utensils in the fryer as most plastics or rubber will become damaged from the hot oil. Do not leave metal utensils in the fryer as they will become hot.
- ❖ After each use, strain oil through a filter or a double thickness of cheesecloth to remove the accumulated residue.
- ❖ The number of times the cooking oil can be reused will depend on the food that is fried in it. For example, the oil will need to be replaced more often if fish, chicken, or food coated with bread or cracker crumbs is fried frequently.
- ❖ It is time to replace the cooking oil if any of the following occur: the oil is dark in color, has an unpleasant odor, smokes when it is heated, or foams excessively during frying.

Frying Timetable

The following times are approximate and based on the maximum recommended amounts of food. Fill the basket no more than $\frac{2}{3}$ full for most foods.

FOOD	QUANTITY	TEMPERATURE	TIME
Cheese, frozen nuggets	6 cups	375°	2 to 3 minutes
Chicken			
Chicken strips	6 cups	375°	2 to 4 minutes
Raw, serving size pieces, breaded	4 to 5 pieces	340°	13 to 18 minutes
Donuts* (fry without the basket)	3 to 4	375°	2 to 3 minutes
Egg Rolls , frozen, thawed	3 to 4	375°	5 to 6 minutes
Fish			
Frozen, battered/breaded	3 to 4 pieces	375°	5 to 7 minutes
Raw, breaded	3 to 4 pieces	375°	3 to 4 minutes
Onion rings			
Frozen, battered/breaded	6 cups	375°	3 to 4 minutes
Raw, battered*	3 to 4 large pieces	340°	1½ to 2½ minutes
Potatoes			
Frozen french fries	6 cups	375°	11 to 13 minutes
Raw fries (see page 8)	3 cups (basket ½ full)	340°	6 to 7 minutes
		375°	10 to 12 minutes
Shrimp			
Frozen, battered/breaded	6 cups	375°	5 to 7 minutes
Raw, breaded	6 cups	340°	2 to 4 minutes
Vegetables, raw, breaded*	5 to 6 pieces	340°	1 to 3 minutes

*These foods are best when fried in small quantities.

Recipes

Raw French Fries (Double Fry Method)

Cut medium potatoes, peeled if desired, into $\frac{1}{4}$ to $\frac{1}{2}$ inch thick strips. Place into large bowl and cover with hot, tap water. Soak potato strips for 15 minutes or until ready to fry. Rinse, drain, and pat dry with paper towels.

Because raw fries contain a high percentage of moisture, extreme care must be used when deep frying. Thoroughly dry raw fries before deep frying. **Fill the basket $\frac{1}{2}$ rather than $\frac{2}{3}$ full.** Keeping the cover open, lower the filled basket slowly into the oil. If the oil starts to boil up too quickly lift the basket out of the oil for a couple of seconds, then lower it again. Repeat as necessary until the basket is completely lowered into the fryer. Close cover.

Fry at 340° for 6 to 7 minutes until fries are cooked through but not browned. Drain; let stand to cool for at least 10 minutes, but not more than 2 hours. Just before serving, fry potatoes at 375° for 10 to 12 minutes or until golden brown.

Crispy Coating

$\frac{1}{2}$ cup milk
1 egg, beaten

Flour
Salt and Pepper

Beat milk and egg together. Combine flour and seasonings. Dip food into milk-egg mixture, then coat in seasoned flour. Fry food according to timetable on page 7.

Beer Batter

$1\frac{1}{2}$ cups flour

$1\frac{1}{2}$ cups beer

Thoroughly combine flour and beer in a large bowl. Cover and allow the batter to sit at room temperature for 3 hours or longer. Dip food in batter and fry according to timetable on page 7. For best results, fry beer battered foods without the frying basket.

Milk Batter

1 cup flour
 $1\frac{1}{2}$ teaspoons baking powder
 $\frac{1}{2}$ teaspoon salt

2 eggs, beaten
 $\frac{1}{2}$ cup milk

Sift together flour, baking powder, and salt. Add eggs and milk. Stir batter until smooth. If a thinner batter is desired, add more milk. Dip food in batter and fry according to timetable on page 7. For best results, fry milk battered foods without the frying basket.

Quesadilla Crispers

$\frac{1}{4}$ pound fresh sausage
(chorizo, Italian, etc.)
1 cup refried beans
 $\frac{1}{4}$ cup finely chopped onion
 $\frac{1}{4}$ cup diced canned green
chilies, drained

$\frac{1}{4}$ pound jalapeño jack cheese,
shredded (1 cup)
8 (7-inch) flour tortillas
1 tablespoon flour
2 tablespoons cold water

Cook sausage until done, breaking it up as it cooks. Combine sausage, beans, onion, chilies, and cheese.

Makes about $1\frac{1}{2}$ cups.

Cut tortillas into quarters. Place about 1 teaspoon of bean mixture in center. Brush edges with mixture of flour and water. Fold in half and press to seal; keep covered as you work. Continue until all are made.

Makes 32.

Let stand 5 minutes before frying to allow edges to stick together. Deep fry 3 or 4 at a time at 375° for 2 minutes. Drain on paper towels.

Apple Pie Fritters

1 cup all-purpose flour	1 tablespoon butter, melted
2 tablespoons sugar	½ tablespoon ground cinnamon
1½ teaspoons baking powder	4 tablespoons sugar
¼ teaspoon salt	3 to 4 apples, peeled, cored, sliced ¼ inch thick
⅔ cup milk, minus 1 tablespoon	2 teaspoons ground nutmeg
1 tablespoon brandy	2 egg whites
1 egg yolk	

In medium bowl, mix together flour, sugar, baking powder, and salt. In a second bowl, whisk together milk, brandy, egg yolk, and melted butter. Gradually stir into dry ingredients until smooth. Set aside.

Mix together cinnamon and sugar. Sprinkle over both sides of apple slices, saving remainder to dust over finished fritters. Sprinkle slices lightly with nutmeg.

In clean bowl, beat egg whites until stiff, but not dry. Fold into reserved batter. Dip several apple slices into batter to coat evenly, letting excess drip off. Carefully place 1 to 2 slices at a time into preheated oil. Deep fry at 375° for 3 to 4 minutes, turning once. Drain on paper towels. Sprinkle both sides with reserved cinnamon and sugar mixture. Best served warm.

Jalapeño Kickers

12 fresh jalapeño peppers or 1 (3½ ounces) can jalapeño peppers	2 tablespoons bread crumbs
Cream Cheese	¼ teaspoon onion salt
½ cup flour	⅛ teaspoon garlic salt
1 egg	¼ teaspoon vegetable oil
½ cup milk	¼ cup flour
	1 teaspoon sugar

CAUTION: Wear plastic gloves when working with peppers. Do not touch eye area.

To prepare fresh jalapeño peppers: rinse, cut in half lengthwise, remove seeds and stems, place in boiling water and remove after 2 minutes; drain well. To prepare canned jalapeño peppers: drain, cut in half lengthwise, and remove seeds and stems.

Fill each pepper half with cream cheese until slightly rounded. Place ½ cup flour in separate bowl, set aside. In a second bowl, beat egg with milk. In a third bowl, prepare breading by combining bread crumbs, onion salt, garlic salt, and oil. Stir in flour and sugar until mixed thoroughly. Roll each pepper in flour, dip in egg mixture, and then cover with breading. For a heavier breading, dip in egg mixture again and cover with breading a second time. Gently set aside until ready to deep fry.

Deep fry at 375° approximately 1 to 2 minutes or until golden brown. (Tip: Remove immediately if cream cheese filling appears through the coating.) Place fried peppers on paper toweling. Serve warm. If desired, serve with salsa.

VARIATIONS: Substitute shredded cheddar cheese in place of cream cheese filling. Pack firmly. Or, substitute a mixture of cream cheese and shredded cheddar cheese in place of cream cheese filling.

Consumer Service Information

If you have any questions regarding the operation of your Presto® appliance or need parts for your appliance, contact us by any of these methods:

- **Call 1-800-877-0441** weekdays 8:00 AM to 4:30 PM (Central Time)
- **Email us at our website www.GoPresto.com**
- **Write:** NATIONAL PRESTO INDUSTRIES, INC.
Consumer Service Department
3925 North Hastings Way, Eau Claire, WI 54703-3703

When contacting the Consumer Service Department, please indicate the model number for the fryer and the series code. These numbers can be found on the bottom of the deep fryer.

Please record this information:

Model Number _____ Series Code _____ Date Purchased _____

Inquiries will be answered promptly by telephone, email, or letter. When emailing or writing, please include a phone number and a time when you can be reached during weekdays if possible.

Any maintenance required for this product, other than normal household care and cleaning, should be performed by our Factory Service Department. Be sure to indicate date of purchase and a description of problem when sending an appliance for repair.

Send appliances for repair to:

CANTON SALES AND STORAGE COMPANY
Presto Factory Service Department
555 Matthews Dr., Canton, MS 39046-0529

The Presto Factory Service Department is equipped to service all PRESTO® appliances and supply genuine PRESTO® parts. Genuine PRESTO® replacement parts are manufactured to the same exacting quality standards as PRESTO® appliances and are engineered specifically to function properly with its appliances. Presto can only guarantee the quality and performance of genuine PRESTO® parts. "Look-alikes" might not be of the same quality or function in the same manner. To ensure that you are buying genuine PRESTO® replacement parts, look for the PRESTO® trademark.

PRESTO® Limited Warranty

This quality PRESTO® appliance is designed and built to provide many years of satisfactory performance under normal household use. Presto pledges to the original owner that should there be any defects in material or workmanship during the first year after purchase, we will repair or replace it at our option. Our pledge does not apply to damage caused by shipping. To obtain service under the warranty, return this PRESTO® appliance, shipping prepaid, to the Presto Factory Service Department or to the nearest Presto Authorized Service Station. When returning a product, please include a description of the defect and indicate the date the appliance was purchased.

We want you to obtain maximum enjoyment from using this PRESTO® appliance and ask that you read and follow the instructions enclosed. Failure to follow instructions, damage caused by improper replacement parts, abuse or misuse will void this pledge. This warranty gives you specific legal rights, and you may also have other rights which vary from state to state. This is Presto's personal pledge to you and is being made in place of all other express warranties.

NATIONAL PRESTO INDUSTRIES, INC.
Eau Claire, WI 54703-3703

Form 72-713C